

CanadaDocks™



Where *fun* on the water *begins!*



Leg Extension

Read this manual and related assembly instructions before attempting to assemble the parts enclosed to ensure that your new CanadaDocks System is assembled safely and correctly.

INCLUDED IN KIT:

GLE8
OR
GLE20



1x

ND38



1x

B3



1x

TOOLS REQUIRED:

9/16" SOCKET WITH RATCHET TO
SUIT OR 9/16" WRENCH

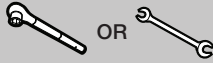

1

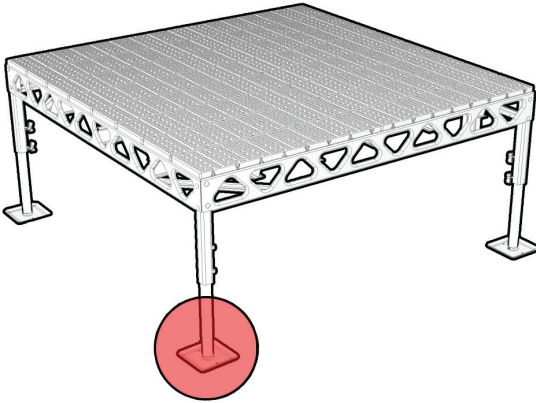

2

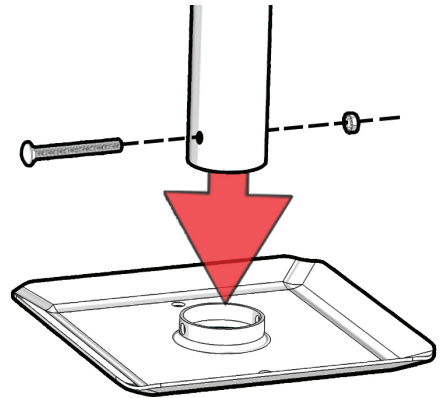

Remove the existing foot from the leg that you wish to extend.

3

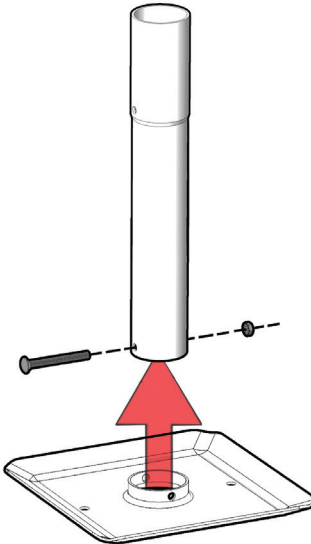

Fasten the foot from the old leg onto the new leg extension with bolt (B3) & dome nut (ND38).

GLE8
OR
GLE20



1x

ND38



1x

B3



1x

4

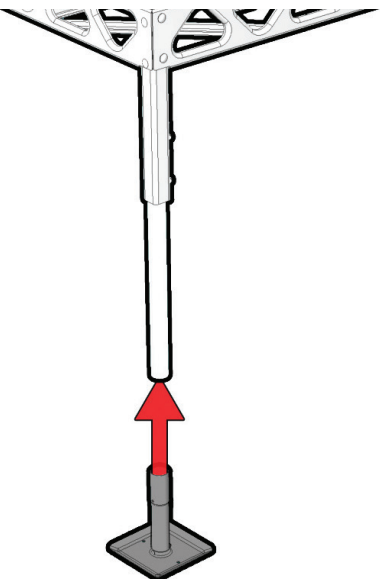

Connection the chain to the chain retainer.

5

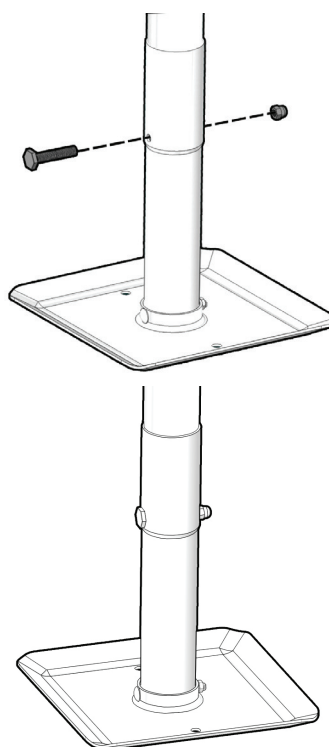

6

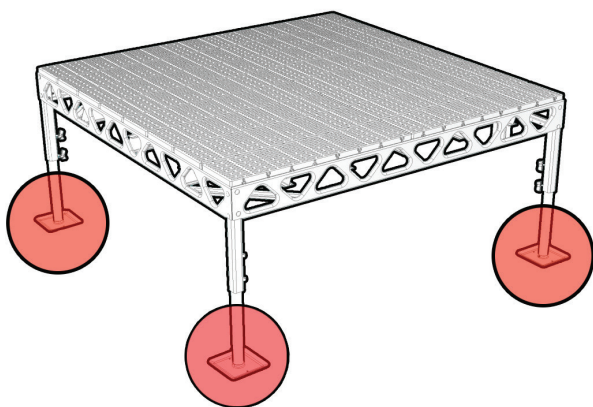

Repeat **STEP 1-5** for any other leg extensions that you need intalled.

Where *fun* on the water *begins!*

Please leave us a **Google review**



We'd love to hear from you and see your photos!



Phone

705.434.0359
1.877.434.0359



Email

info@canadadocks.ca



Address

3690 Adjala-Tecumseth Tl,
Beeton ON L0G 1A0

CanadaDocks.ca

